



HOMMEL-ETAMIC roundscan Fast, accurate form and roughness measurement



Precision is our business.

Your partner for industrial metrology

Hommel-Etamic, the Industrial Metrology Division of the Jenoptik Group, is a leading manufacturer and system provider of high-precision, tactile and non-tactile production metrology. The range of products provided include total solutions for a wide range of measurement tasks such as testing surfaces, form, and determining dimensional tolerances – throughout all phases of the production process, for final inspection or in a metrology lab. Our product portfolio is rounded off by a wide range of services in consulting, training and service, including long-term maintenance contracts.

Hommel-Etamic. Precision is our business.

Form and roughness measurement

Once machined, each workpiece exhibits varying degrees of deviation from the geometrically ideal form. Even the slightest deviation from the reference form and surface can significantly affect a component's func-

tionality. Determining form and roughness deviation is particularly important between like parts with common features.

Form deviation and surface texture measurements provide information on the quality of the finished components and enable conclusions to be drawn on the quality of the overall production process, thereby helping to reduce costs.

Twist measurements on gear shafts, for example, are also becoming increasingly important. The ideal solution here is a combined measuring system for form, roughness and twist measurement.

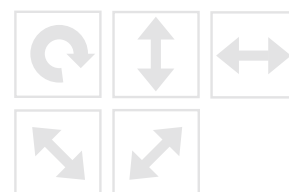

HOMMEL-ETAMIC roundscan 555 with optional printer container

Innovative measuring station for form and roughness measurement

Maximum precision with minimum consequential costs
The high precision measurement of form and roughness demands a measuring system with a high resolution and maximum accuracy of the axes. The rotary table is on an air-bearing and is thus wear-free, enabling an excellent roundness accuracy of 20 nm. Thanks to its high rigidity (10 times greater than conventional air-bearings) it ensures maximum precision at all times.

The Fourier analysis is also precisely determinable in high frequency ranges.

Automatic form and roughness measurement

The CNC-controlled rotation and tilt module positions the stylus tips both for the form and roughness measurement anywhere on the workpiece. All measurement positions can be probed automatically in one measurement run.

Fast thanks to a unique drive system

Very fast, CNC-controlled measuring axes can be moved completely parallel. The roundscan is also equipped with

a new kind of drive system for fast automatic centering and leveling. The scanning function provides additional support here for large and heavily eccentric parts. In this way, the measurement and alignment times are reduced by up to 60 % in comparison with conventional measuring systems.

Ergonomic measuring station design

The height adjustable, tiltable evaluation unit is completely independent of the measuring station and can be set to the respective application within seconds.

The "measurement" and "programming" works steps were analyzed exactly according to ergonomic factors and optimized for the convenient standing and sitting workstation of the roundscan. The accommodation of the evaluation computer and the printer in lockable cabinets rounds off the ergonomic concept and offers additional storage possibilities. You can perform the most important functions on the control panel with a direct view of the measuring task.



Integrated probe arm rest



Height adjustable
evaluation unit

Configurable for the optimum measurement situation

The combined roundscan form and roughness measurement system can be configured depending on the measuring task to create the optimum measurement situation. The vertical Z-axis of the roundscan is available in three versions: 350, 550 or 900 mm (maximum measurement height).

- Small parts such as valves can be measured with a small measuring circle.
- For the measurement of long and heavy workpieces, test diameters of up to 490 mm, measuring heights of up to 900 mm and table loads of up to 100 kg are possible.
- An active damping system and an adaptive enclosure are optionally available for close-to-production application.

Features of the roundscan systems

- 3 fully CNC-controlled measuring axes for measuring all common form and position parameters
- New, fully automatic centering and leveling system reduces setup times by up to 60 % in comparison to conventional measurement instruments
- C-axis located on an air-bearing, delivering maximum precision for part weight up to 60 kg (100 kg possible for special applications)
- Innovative FT3 probing system for measurement of form, roughness and twist standards without changing the measurement stylus

Basic version for form measurement

- Resolution of the R/Z axis 1 μm
- Rotary table with rubber damping
- Resolution of the C-axis 20,000 points

High resolution version for form and roughness measurement

- Resolution of the R/Z axis 0.1 μm
- Integrated linear scale for the scanning operation and high precision positioning
- Rotary table: air damping with active level control
- Resolution of the C-axis 360,000 points

roundscan systems are completely modular and can be upgraded using current and future components, guaranteeing functionality into the future.



HOMMEL-ETAMIC roundscan 590

Combined form and roughness measurement

Innovative FT3 probing system for efficient measurements

A new probing system enables measurements with two different stylus tips: ruby ball for form and diamond tip for roughness. The adjustable probing force ensures measurements in accordance with standards. The probing system can be switched over from form to roughness during the CNC run without changing the stylus tip. The roundscan offers the necessary prerequisites for form and roughness and therefore also twist measurements.

Properties for roughness measurement in accordance with standard

- Roughness measurement possible with the R, Z and C-axis
- Automatic probing force switching
- High resolution of the axes with up to 360,000 points for as small a measuring point distance as possible
- Low traverse speed from 0.2 mm/s can be run
- Only very low basic interference of the measuring axes at maximum resolution
- Excellent collision protection by magnetic coupling of the probe arms

Reliable measurement results

The measurement of form and roughness can be programmed fully automatically. Since the form and roughness measurements run combined, no intervention from the operator is necessary. There are no long retooling times because the workpiece only has to be positioned once for the form and roughness measurement. This enables fast, reproducible measurements. The roughness parameters and form parameters are shown with the appropriate tolerances in the evaluation report in a table. This ensures fast, reliable interpretation of the measurement results.

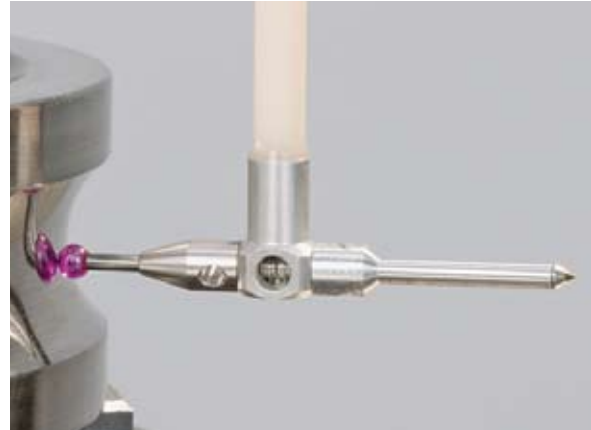

Form measurement with ruby ball



Roughness measurement with diamond tip



Collision protection by magnetic holder

Evaluation software with characteristic-orientated user guidance

TURBO FORM is a function orientated, graphical user interface that ensures simple user control even for complex measurement tasks. Starting with simple definitions of measurement positions and axis references, through fully automatic alignment and measurement of the workpieces, to a comprehensive profile analysis and continuous documentation of the test results, TURBO FORM delivers user friendly results.

The user interface can be tailored individually for any test plan. All common form and position parameters are calculated with TURBO FORM according to current standards. The function key bar, which can be operated using the mouse or keyboard, ensures maximum operating convenience. The software is open for an unlimited number of measuring programs and reports.

The features of TURBO FORM at a glance

- Clear program run
- Direct transfer of positions by teach-in
- User-friendly interface with clear icons
- Simple CNC programming by pictograms
- Evaluation in accordance with standards
- Convenient test plan management
- Numerous options for special applications
- Fast evaluation algorithms for prompt results
- CNC modules, Fourier analysis and 3D analyses included in the standard scope of delivery
- User-defined display of measuring reports, screen and print forms

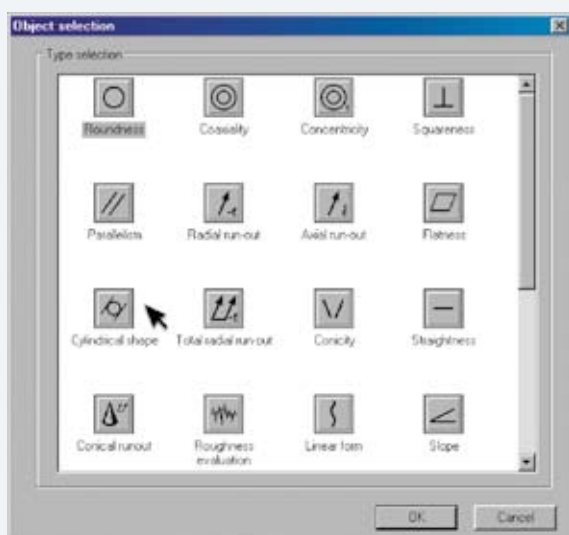

Test plan creation

Select the desired characteristic with a mouse click. The wizard guides you simply and safely through all the necessary steps.

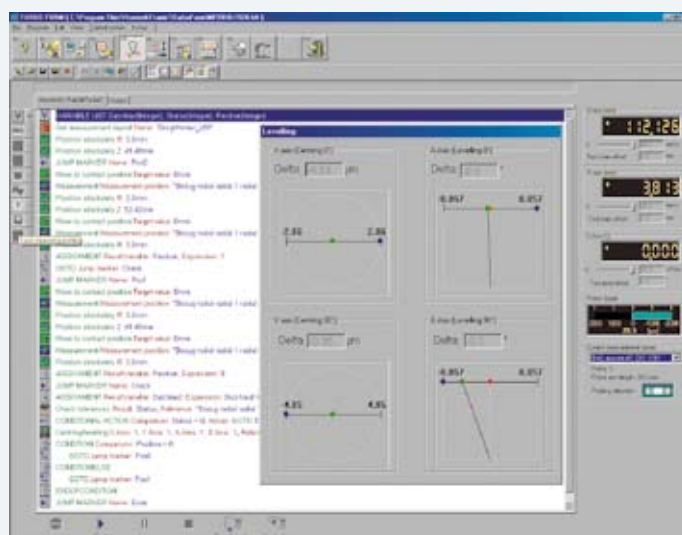

Automatic alignment

Alignment takes place automatically and reduces setup times by up to 60 % in comparison to conventional measurement instruments. After specification of the measurement positions, the software creates the CNC program for the alignment run, which in most cases is integrated directly into the complete CNC run of the measurement.

Software Options

In addition to the many different functions in the standard version, numerous options for the evaluation of special measurement tasks as well as for fast, simple data export are available for TURBO FORM.

Evaluation of special measurement tasks

- Profile any line
- Angular sector
- Fourier synthesis
- Cone
- Piston
- Brake disk
- Crowning
- Profile any surface
- Roughness
- Twist

Export interfaces

- qs-STAT®-interface, certified according to AQDEF
- ASCII export interface
- PDF output

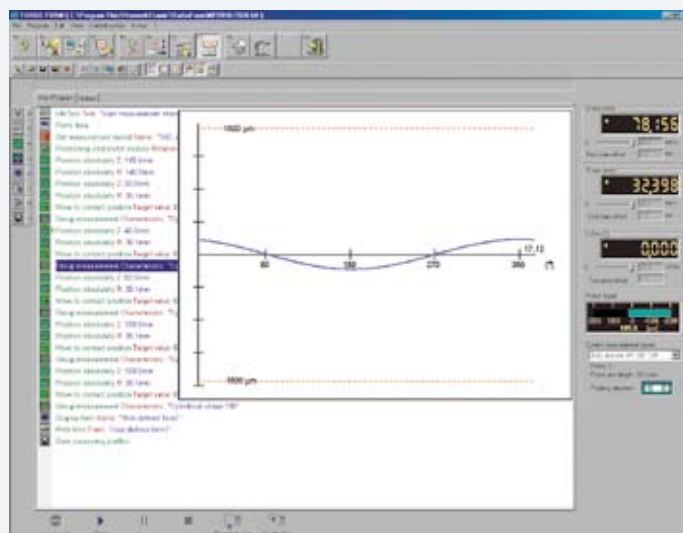

Automatic measurement runs: CNC

The aligned workpiece is measured in the CNC run. This takes much less time than a manual measurement sequence and provides operator-independent, reproducible results. CNC programs are created by single steps in the teach-in mode and can then be changed step by step, either as a total measurement run or in single steps.

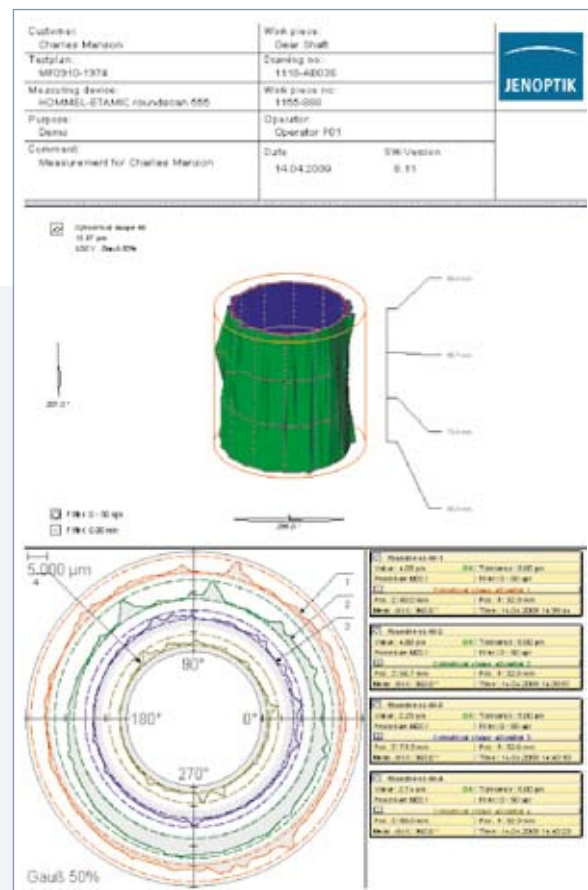

Analysis/documentation

After scanning the workpiece, the measurement profiles are displayed clearly in (3D) diagrams and according to the current standards. Printing and saving of the reports can be integrated directly into the automatic run. It is also possible to export the measured data via one of the optional interfaces.

Evaluation of roughness, waviness and profile (option)

This module allows fast, simple calculation, evaluation and graphic representation of all common roughness, profile and waviness parameters according to the DIN/EN/ISO/JIS standards.

Various standard forms are available to the user for evaluation. After selecting the desired format the measurement conditions can be configured clearly and easily. The parameters are collected individually according to the measurement task. A wide range of display possibilities simplify the profile analysis, e.g. superposition of several profiles, zoom, filter or extraction of faults.

You also have the possibility of designing screen and print forms completely freely and individually. All the form and roughness parameters can be shown clearly in a characteristics table. The important information is visible at a glance in the tolerance output and the status display.

Automatic roughness evaluation (CNC)
Roughness measurement positions are integrated into the CNC run by the appropriate program button. Measurement conditions such as probing force are adapted automatically. The results are displayed directly in the automatic measurement run and printed as required. They can also be saved as a PDF file or exported via the ASCII or qs-STAT® interface (optional).

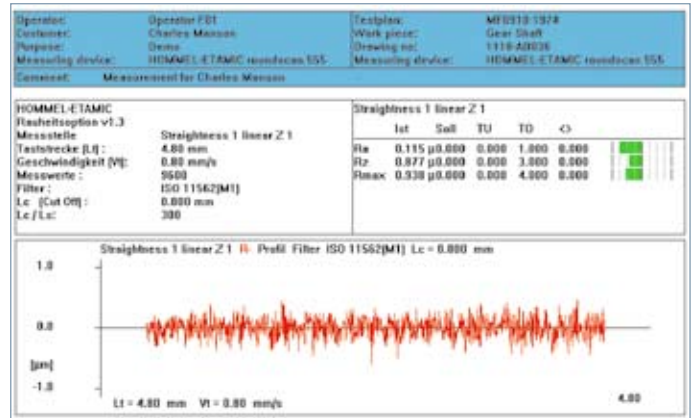

Roughness parameters and roughness profile

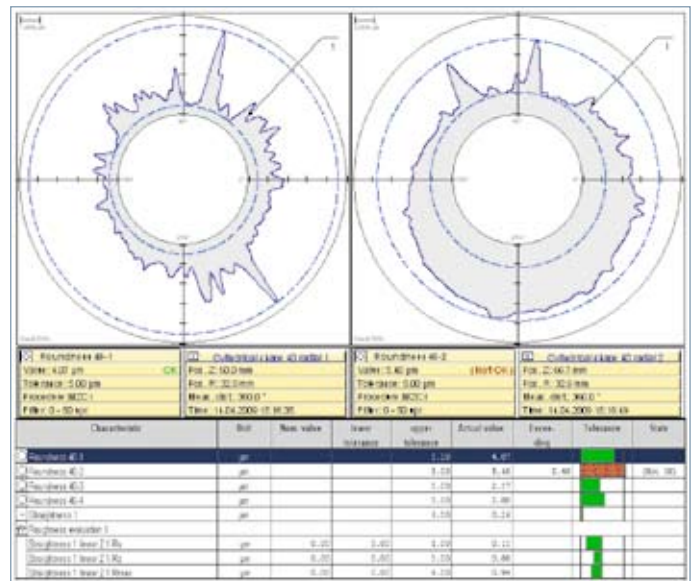

Result report

TwistLive® - Fast twist measurement according to MBN 31007-7

Twist refers to periodic structures which are comparable with the course of a thread. Magnified many times, it is visible as a micro-grinding structure. Twist structures at the sealing surfaces of shafts occur during grinding and impair the sealing function between the shaft and the sealing ring.

The most important properties of these structures can be determined with a 3D evaluation of the surface. The contact zone of the shaft is measured as a 3D area with a roughness stylus tip over a series of envelope line profiles. This allows a graphic representation of the twist structure as well as calculation of the twist parameters. All roundscan form measuring instruments support the current version of the Daimler standard MBN 31007-7 from 2009. This means that all new parameters such as the theoretical feed cross section per revolution DFu or the contact length in percent DLu can be determined with optimized evaluation algorithms. Depending on the measuring instrument, measurements for complete surface analysis take several minutes.

With the TwistLive® analysis method from Hommel-Etamic, the normal measurement time may be reduced by 75 %.

During the measuring progress, a results forecast of the twist parameters is already possible - live!

Twist parameters

Number of threads DG

Twist depth Dt [μm]

Period length DP [mm]

Feed cross section DF [μm^2]

Feed cross section per revolution DFu [$\mu\text{m}^2/\text{r}$]

Contact length in percent DLu [%]

Twist angle Dy [°]

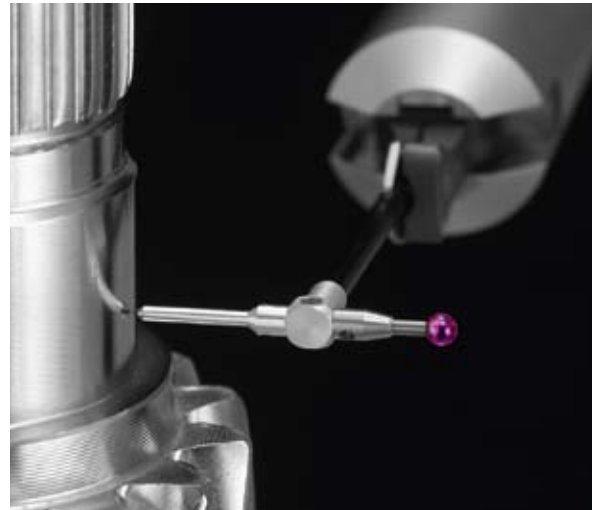

Twist measurement with a roughness stylus tip

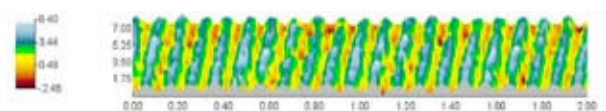

Display of unfiltered primary surface structure

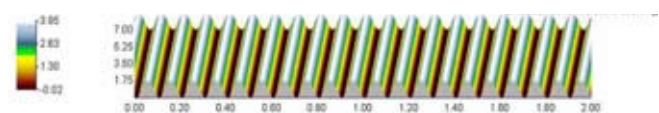

Display of twist structure in detailed scaling

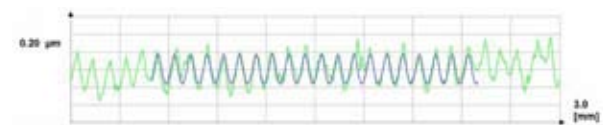

Display of original profile (green) and twist profile (blue)

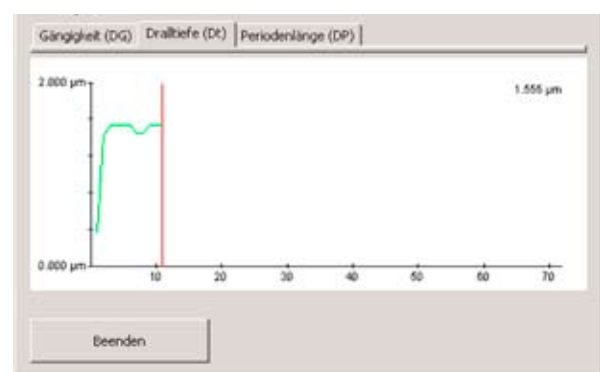

TwistLive® - live display of the measuring results

Solutions for workpiece-specific applications

Thanks to an extensive range of accessories, the roundscan is suitable for many different measurement tasks. Standard or tailor-made systems can be created for almost any application. Benefit from years of experience and extensive knowledge in metrology solutions by choosing Hommel-Etamic.

Application examples from the automotive industry

- Gear shaft
- Injection parts
- Brake disk
- Piston
- Valve
- Con rod
- Bearing ring

Injection parts

The special version of the Z-axis very close to the rotary table allows a small measuring circle and maximum precision. Hommel-Etamic offers specially adapted clamping devices for the CNC measurement of different injection parts.

Gear shaft

Productivity is increased by up to 70 % through the combined evaluation of all form and roughness parameters in one CNC run.

Piston measurement

Measurement of piston outer shapes, pin axis, ring grooves and piston covers. Evaluation of non-standardized characteristic types on the piston, such as evaluation of the ovality, reference pin axis, or linear form, are also possible.

Brake disk measurement

Evaluation of critical brake disk features such as stagger, thickness variation, waviness and wear measurements.

Con rod

For roundness and parallelism measurements on pin and crank bore diameters. Also for evaluation of twist and bend features.

Bearing ring

Exact Fourier analysis and synthesis also in high frequency ranges. Evaluation of the swing speed.



Measurement on an injection part



Measurement on a gear shaft

Accessories for different applications

We offer a wide range of accessories for the safe handling of complex workpieces with the roundscan. In addition to the standard versions you also receive accessories specially made for your measurement task.

FT3 probe

The FT3 measurement probe is contained in the standard scope of delivery and has a measuring range of $\pm 1500 \mu\text{m}$ with excellent linearity. Measurement force and scanning direction can be set automatically by CNC. The changeable probe arms are mounted easily and safely by a magnetic coupling. Art. 1002 5585



Enclosure

For use in production. With a manual aluminum shutter and Macrolon glazing on three sides. Art. 1004 0182

Motorized probe rotation and tilt module MDS

The motorized rotation and tilt module MDS enables fully automatic axial and radial measurements without interrupting the CNC run. It has one motorized axis each for tilting (90°) and rotating (360°) the measurement probe and is therefore able to reach measurement positions which are difficult to access. The autostop function has an intelligent, computer-aided start-up aid with automatic detection of the probing direction. Art. 513 253



Chuck

With three, six or eight hardened clamping jaws for secure clamping of the workpieces on the rotary table.

Chuck FX70

Clamping range
Inside 18-62 mm
Outside 2-68 mm
With 3x M5
With 3-point ball rest



Art. 232 036
Art. 518 938

Chuck FX100

Clamping range
Inside 28-95 mm
Outside 2-95 mm
With 3x M5
With 3-point ball rest



Art. 232 357
Art. 518 939

Chuck FX150

Clamping range
Inside 46-140 mm
Outside 2-140 mm
With 3x M5
With 3-point ball rest



Art. 232 359
Art. 518 940

Ceramic probe arms – the basis for high precision measurement

Probe arm set FTS3

To cover the most frequent measurement tasks.

Art. 1002 9224



The parts of the probe arm set can also be ordered individually.

- Stylus tip FO KE300/90H L10 D2/10
L = 10 mm; 2 cone tips Art. 519 520
- Stylus tip FO KE300/90H L35 D2/35
L = 35 mm; 2 cone tips Art. 241 712
- Stylus tip FO KE300/90H L10,4 D4-2
L = 10,4 mm; cone tips Art. 243 519
- Pin wrench M2 Art. 051 215
- Extension L060
L = 60 mm; M2 thread Art. 1003 4259
- Stylus tip M2 KU1000/R L20
L = 20 mm; 2 mm ruby ball;
M2 thread Art. 051 207

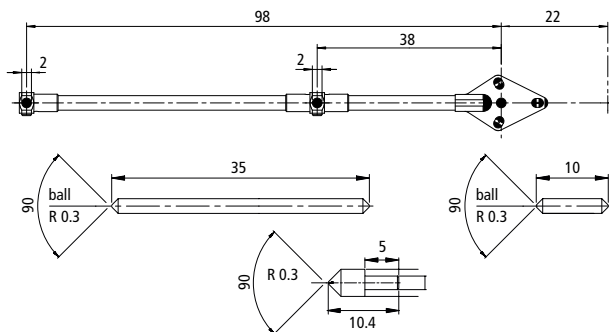

- Probe arm FTM-HR-L038*098 - M2*M2
Two 2 mm bores for inserting stylus tips. The stylus tip at 38 mm is suitable for the outside measurement; the stylus tip at 98 mm is used for measurements in bores.
L = 38 mm + 98 mm Art. 1003 0456

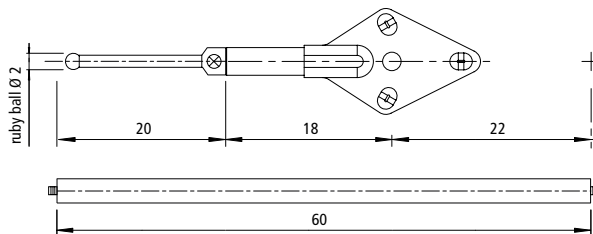

- Probe arm FTM-HA-L018-M2
M2 thread for screwing on stylus tips.
L = 18 mm Art. 1000 3942

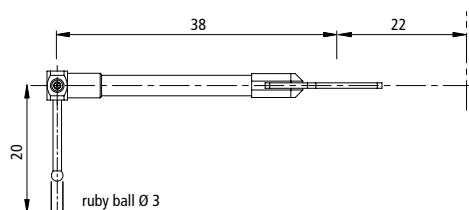

- Standard probe arm with stylus tip
Delivered with every device.
Probe arm FTM-HR-L038-D2
L = 38 mm Art. 1000 3955
- Probe arm FO KU1500/R L20 D2
L = 20 mm; 3 mm ruby ball Art. 243 877

Probe arms with M2 thread and matching stylus tips

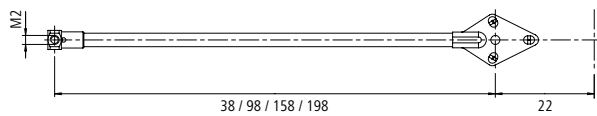

Probe arm FTM-HR-Lxxx-M2

Lateral M2 thread for screwing on stylus tips.

L = 38 mm	Art. 1000 3938
L = 98 mm	Art. 1000 9711
L = 158 mm	Art. 1000 9714
L = 198 mm	Art. 1003 8257

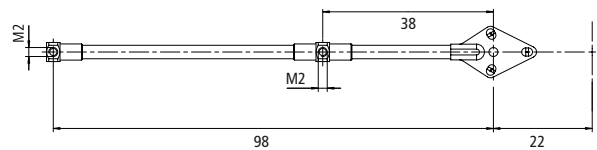

Probe arm FTM-HR-L038*098 - M2*M2

Two lateral M2 threads for screwing on stylus tips.

L = 98 mm + 38 mm	Art. 1002 4596
-------------------	----------------

Stylus tips M2 with ruby ball

Standard stylus tips for precise form measurement.

Stylus tip M2 KU1000/L10,0 D1,0

L = 10 mm; 2 mm ruby ball;

Art. 051 208

Stylus tip M2 KU1000/L15,0 D1,0

L = 15 mm; 2 mm ruby ball;

Art. 1002 9794

Stylus tip M2 KU1000/L20,0 D1,0

L = 20 mm; 2 mm ruby ball;

Art. 051 207

Stylus tips M2 with diamond tip

For the exact determination of the surface parameters.

Stylus tip M2 KE5/90GD L05,0

L = 5 mm; diamond tip 90°/5 µm;

Art. 1002 9793

Stylus tip M2 KE5/90GD L15,0

L = 15 mm; diamond tip 90°/5 µm;

Art. 1002 5091

Stylus tips M2 with cone

For measurements on ground and lightly soiled measuring points.

Stylus tip M2 KE300/90H L5,0

L = 5 mm; cone tip 90°/R 0,3 mm;

Art. 1004 4157

Stylus tip M2 KE300/90H L10,0

L = 10 mm; cone tip 90°/R 0,3 mm;

Art. 1004 4188

Stylus tip M2 KE300/90H L15,0

L = 15 mm; cone tip 90°/R 0,3 mm;

Art. 1004 4189

Special probe arms for measurements in small bores from 3 mm

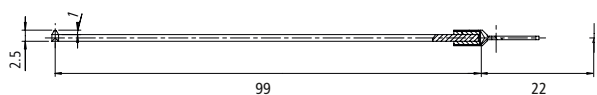

Probe arm FTM-R-L099-KE0,3-60H

For form measurement.

L = 99 mm; cone tip 60°/R 0,3 mm;

Art. 1001 1703

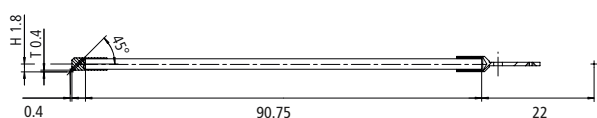

Probe arm FTM-R-L098-KE0,005/60D

For roughness measurement.

L = 98 mm; diamond tip 60°/5 µm;

45° mounting;

Art. 1004 0375

L = 98 mm; diamond tip 60°/5 µm;

45° mounting;

Art. 1004 0389

Permanent measurement accuracy

DAkKS calibration laboratory

Continuous monitoring of optimum measurement accuracy is necessary to ensure perfect functioning of the measuring instruments. This is because changes in function can occur over the course of normal use, especially due to wear and tear, and these types of changes can go unnoticed. We calibrate the standards you send us in our ISO/IEC 17025 accredited DAkKS calibration laboratory. This ensures direct tracing of the gauging components to the Federal Physical-Technical Institute (PTB) and guarantees measurements and calibrations at the highest technical standard for measuring.

If a standard cannot be calibrated, a new one can be obtained directly from any of our manufacturing facilities. Simple factory calibration certificates and test reports for non-accredited parameters are also available. We also carry out capability tests for demanding measurement tasks.

Our range of calibration services:

Our DAkKS accreditation includes the measurement of variables such as roughness, profile depth, roundness, straightness, and parallelism as well as contour standards and roughness measurement instruments. Within this scope we offer:

- DAkKS calibration certificates for form standards
- DAkKS calibration certificates for contour standards
- DAkKS calibration certificates for roughness standards
- DAkKS calibration certificates for roughness measurement systems

DAkKS calibration certificate for form standards

Calibration is carried out on our DAkKS measuring station in an air-conditioned, vibration-insulated measuring room. All common form characteristic values can be determined.

Magnification standard FN101

For inspecting the amplification of the probing system

With test report

Art. 521 809

With DAkKS calibration certificate

Art. 532 528



Roundness standard FN111

Made of ceramic. For inspecting the radial roundness deviation of the rotational axis.

With test report

Art. 521 799

With DAkKS calibration certificate

Art. 532 529



Roughness standard RNDX2 with standard holder FNR

Standard holder FNR for one or two geometry standards of the RNDH or RNDX type. For inspecting the roughness measurement of the Z and R-axis.

Geometry standard RNDX2 made of nickel with an extra hard protective coating.

Triangular/sinusoidal grooves.

Delivered with test report.

Ra: approx. 1.0 µm;

Rz: approx. 3.3 µm

Art. 1003 4205

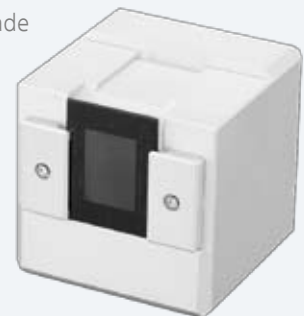

Set of twist standards

With 10 and 30-turn left twist. For inspecting the accuracy of the measuring systems.

Delivered with test report.

Art. 1001 6265



Technical data

	HOMMEL-ETAMIC roundscan 535 Art. 1003 8285 Art. 1003 8286	HOMMEL-ETAMIC roundscan 555 Art. 1003 8287 Art. 1003 8288	HOMMEL-ETAMIC roundscan 590 – Art. 1003 8303
basic high resolution			
Max. workpiece diameter	740 (840) mm	740 (840) mm	740 (840) mm
Max. test diameter	390 (490) mm	390 (490) mm	390 (490) mm
Max. measurement height	350 mm	550 mm	900 mm
Max. load	600 (1000*) N	600 (1000*) N	600 (1000*) N
C-axis			
Table diameter	330 mm	330 mm	330 mm
Workpiece alignment	automatic	automatic	automatic
Roundness deviation ($\mu\text{m} + \mu\text{m}/\text{mm}$ measurement height)	0.02 + 0.0005 μm	0.02 + 0.0005 μm	0.02 + 0.0005 μm
Roundness deviation ($\mu\text{m} + \mu\text{m}/\text{mm}$ measurement height)**	0.01 + 0.00025 μm	0.01 + 0.00025 μm	0.01 + 0.00025 μm
Roundness deviation ($\mu\text{m} + \mu\text{m}/\text{mm}$ measurement radius)	0.03 + 0.0005 μm	0.03 + 0.0005 μm	0.03 + 0.0005 μm
Roundness deviation ($\mu\text{m} + \mu\text{m}/\text{mm}$ measurement radius)**	0.015 + 0.00025 μm	0.015 + 0.00025 μm	0.015 + 0.00025 μm
Centering range	± 5 mm	± 5 mm	± 5 mm
Leveling range	$\pm 1^\circ$	$\pm 1^\circ$	$\pm 1^\circ$
Measuring and positioning speed	0.2 – 30 1/min	0.2 – 30 1/min	0.2 – 30 1/min
Bearing	air	air	air
Z-axis			
Measuring length	350 mm	550 mm	900 mm
Straightness deviation / 100 mm	0.15 μm	0.15 μm	0.25 μm
Straightness deviation / measuring length	0.3 μm	0.45 μm	1.5 μm
Parallel C-Z	0.5 μm	0.8 μm	2.5 μm
Measuring and positioning speed	0.2 – 50 mm/s	0.2 – 50 mm/s	0.2 – 50 mm/s
R-axis			
Measuring length	220 mm	220 mm	220 mm
Straightness deviation / 100 mm	0.25 μm	0.25 μm	0.25 μm
Straightness deviation / measuring length	0.5 μm	0.5 μm	0.5 μm
Squareness C-R	0.8 μm	0.8 μm	0.8 μm
Measuring and positioning speed	0.2 – 50 mm/s	0.2 – 50 mm/s	0.2 – 50 mm/s
Dimensions / weight			
Length	1990 mm	1990 mm	1990 mm
Depth	750 mm	750 mm	750 mm
Height	1760 mm	1960 mm	2310 mm
Weight approx.	650 kg	665 kg	685 kg

All accuracy data in accordance with ISO 1101 at 20°C \pm 1°C in vibration-neutral environment, filter 0 – 15 W/U LSCI or 2.5 mm LSLI; 6 rpm, or 4 mm/s. Standard probe arm with 1 mm ruby sphere.

All proof on the standard under inclusion of the compensation method.

* Available as an option; changed technical data on request.

** Values as maximum deviation from the reference circle LSCI, filter 0 – 15 W/U LSC, 6 rpm.



Our global presence.

- | | | |
|-------------|----------------|-------------|
| Germany | Spain | Mexico |
| France | Czech Republic | China |
| Switzerland | United States | South Korea |
| | | India |

Group companies, affiliates and representation worldwide

www.hommel-etamic.com